

Zip FlushMaster[®] Pearl & Zip FlushMaster[®] Mk.2

Water Saver Urinal Flushing System

Keeps Urinals Clean & Reduces Water Wastage

Instructions for Models: WS003; WS004; WS006; WS007 and 99168 Sensor.

WS003

WS004



41091 Zip FlushMaster Pearl
Compact Recessed Sensor & Solenoid
DC WS004. With 64mm body

41095 Zip FlushMaster MK2
Recessed sensor & Solenoid
DC WS003. With 105mm body



Table of Contents

Key Features	3
Read These Warnings First.....	3
Check Your Package.....	3
Installation Procedure	3
Set Up Water Discharge	4
Install Sensor.....	6
Connect Latching Valve Cable.....	7
Connect Optional Power Pack.....	8
Set Flush Timing.....	8
Completing Installation	9
Maintenance Instructions.....	10
Problem Solving.....	11
Contact Details	12

Accessories

You may need these accessories (see page 3 for package contents).

41092 Mk 2 Retrofit Sensor DC (105mm body) WS006 (Valve assy not included)
 41093 Mk 2 Retrofit Sensor AC (105mm body) WS007 (Valve assy not included)

99168 Pearl Water Saver Sensor only (64mm body)



99021 Zip FlushMaster Cistern Autosyphon 1.00 inch BSP/ 25 mm
 99022 Zip FlushMaster Cistern Autosyphon 1.25 inch BSP/ 32 mm
 99023 Zip FlushMaster Cistern Autosyphon 1.50 inch BSP/ 38 mm



99024 Zip FlushMaster Direct Injection Airbreak 1.00 inch BSP / 25 mm
 99025 Zip FlushMaster Direct Injection Airbreak 1.25 inch BSP/ 32 mm
 99026 Zip FlushMaster Direct Injection Airbreak 1.50 inch BSP/ 38 mm

99031 Zip FlushMaster AC Power Pack

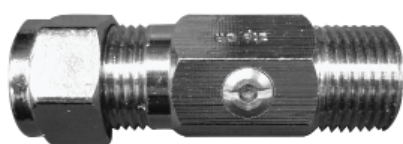

99039 -Restrictaflow

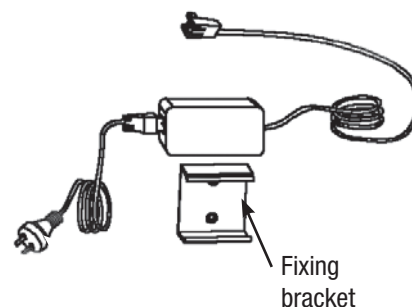

Fixing bracket

Key Features

One of the world's most effective, ceiling recessed, urinal flushing systems.
Battery operation (FlushMaster only) for simple, inexpensive installation.
Optional power pack for connection to 220-240 volt AC power.
Variable flush cycle to meet your needs precisely.

Read These Warnings First



Read all instructions before attempting to install this system.
Never attempt to install this system without reading all instructions.
Designed for indoor use only do not expose to elements of nature.
All plumbing connections must be made in accordance with AS3500.
Supply pressure 350kPa - 700kPa

Check Your Package

Zip FlushMaster package includes.



Product Code 41091
Zip FlushMaster WS004
Ceiling recessed sensor
complete with latching
valve, 6V Battery and
brass fittings with
restrictaflow.
64mm Body



Product code 41095
Zip FlushMaster Mk.2 WS003
Ceiling recessed sensor,
complete with latching valve, 6
V Battery and brass fittings with
restrictaflow
105mm Body



Product code 90281
Latching valve and brass fittings
with flow restrictor

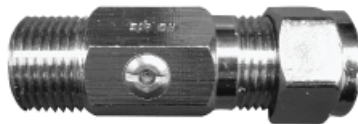

Installation Procedure

1. Set up water discharge
2. Install sensor
3. Connect latching valve cable
4. Set flush timing

Set Up Water Discharge

Typical Installation with Cistern

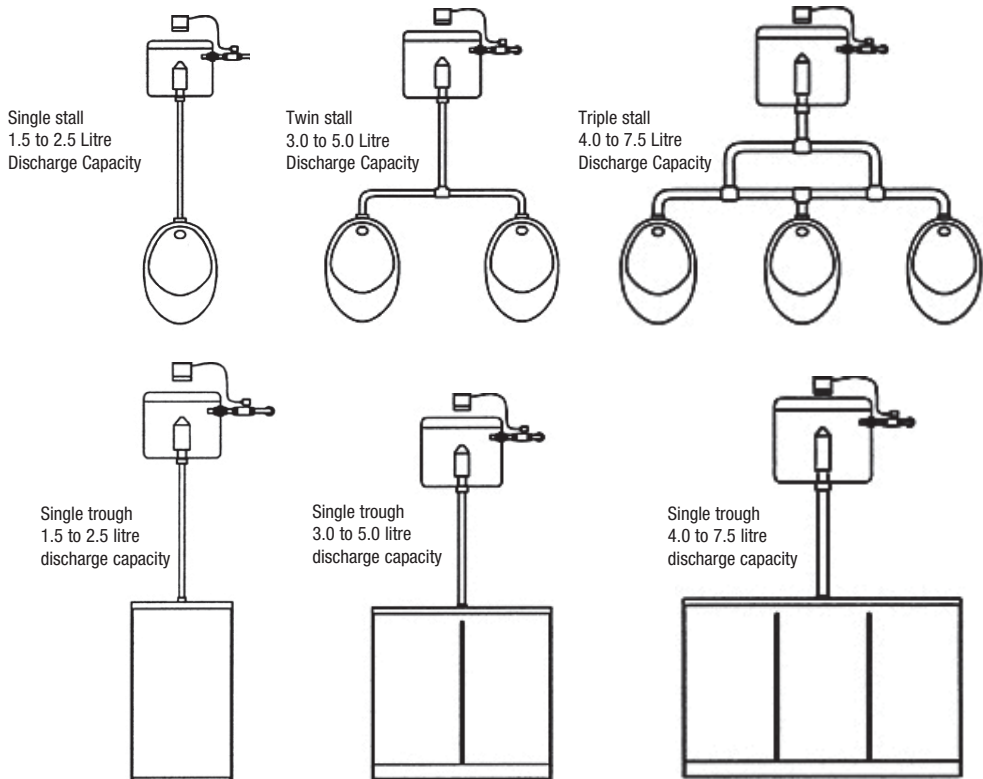

Typical Installation with Direct Injection

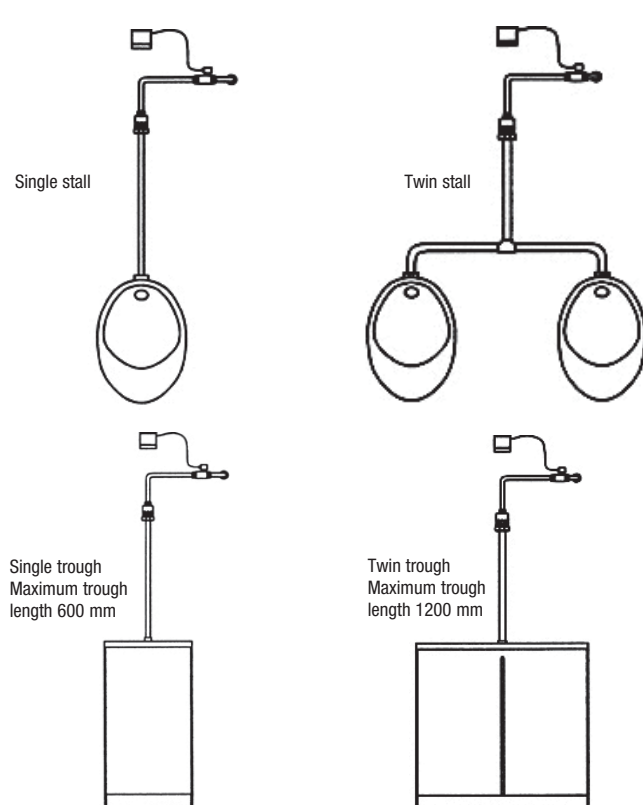

Flow restrictor Installation Notes:

- The Restrictaflow must be fitted between the isolating valve (not supplied) and the latching valve (see page 5).
- The Restrictaflow is designed to save water and to reduce the flow, particularly when used on single stall installations.
- The Restrictaflow may be drilled out (in 0.5mm increments) or removed when servicing multiple stalls and a higher flow is required, or when there is insufficient water pressure.
- The Restrictaflow is normally required with operating pressures greater than 700kPa.
- An Isolating valve must be supplied and installed in accordance with AS/ NZS3500

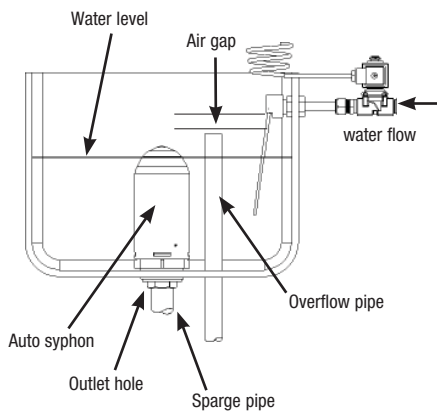

Autosyphon Installation

- More than one cistern can be fed from a single latching valve, but for accurate balancing, do not connect together more than two cisterns.
- The balance of water can be achieved by keeping the supply pipe length to each cistern as equal in length as possible.
- If this is not practical fit a flow restrictor of equal rating at the entry to each cistern.
- Remove the existing filling mechanism from the cistern, including the float and aspirin washer, to permit unrestricted inlet of the water. The flow of water into the cistern is controlled by the latching valve.
- Remove the existing manual flushing mechanism from the cistern, and fit the syphon to the outlet hole as shown in the diagram. Connect the sparge pipe to the protruding thread from the syphon.

Note: To adjust the auto syphon height within the cistern, add a second locking nut to the inside of the cistern and wind second nut up or down.

- Adjust the height of the syphon so that the flush triggering level remains below the level of the cistern overflow pipe.
- An air gap must always remain between the cistern water level and the inlet water pipe level, to prevent backflow.

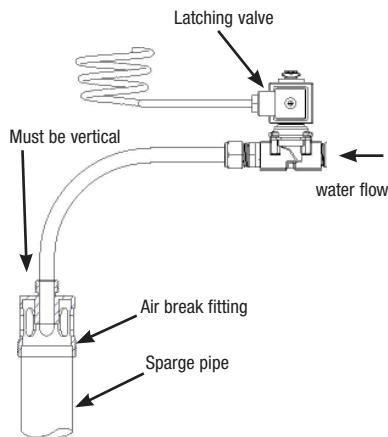

Airbreak Installation

- The air break must be fitted in a vertical position. Fitting in a position other than vertical will result in leakage.
- Fit the air break to the top of the urinal sparge pipe (in place of a cistern), as shown in the diagram.
- Do not use sealing tape in the joints. Both the air break and the latching valve use compression connections fittings. Sealing tape is not required.
- Supply and install a half-inch pipe from the top of the air break, to the outlet side of the latching valve.
- Securely fix the piping to the wall as per AS/NZS3500 to prevent possible tampering and vandalism.
- Adjust the timing of the flush to ensure an adequate flush, by setting the flush cycle switches on the sensor (see page 9).

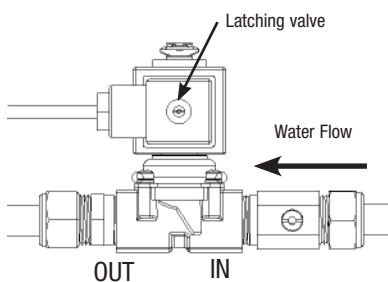

Restrictor installation:

Fit the Restrictaflow between the tap and the latching valve (see below). The Restrictaflow must be connected to the valve port marked IN.

NOTE: The valve must be installed with the INLET and OUTLET ports oriented with the water flow (as shown above). The valve body is marked IN and OUT. Incorrect assembly will result in damage to the diaphragm.

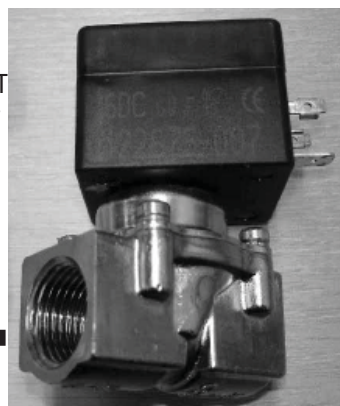

Restrictaflow



outlet to airbreak ←

Install Sensor

Typical Installation with Ceiling Recessed Sensor

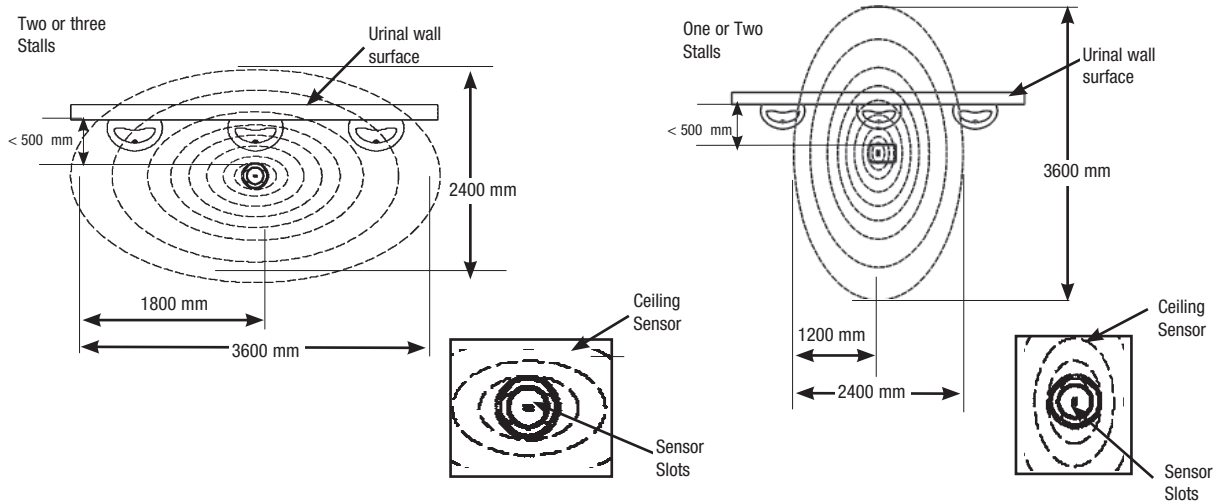

Position the ceiling sensor not more than 500 mm from the urinal wall. Sensor coverage from a 2700 mm ceiling is approximately 2400 x 3600 mm.

For a single stall urinal, position the sensor above the centre of the stall. Position the sensor slots at right angles to the urinal wall.

For a double stall urinal, position the sensor midway between the stalls. Position the sensor slots at right angles to the urinal wall.

For a triple stall urinal, position the sensor above the centre of all three stalls. Position the sensor slots parallel to the urinal wall. For more than three stalls, use additional sensors.

Warning. Do not connect battery or power pack until all plumbing connections are completed. The power must be connected last as connection activates the system test mode (see page 8).

To install a ceiling recessed sensor:

WS004 and 99168, will require a 64 mm diameter hole in the ceiling.

WS003; WS006 and WS007 will require a 105mm diameter hole in the ceiling

Use inbuilt clips to fasten sensor housing in place when inserted into hole. (see diag below)

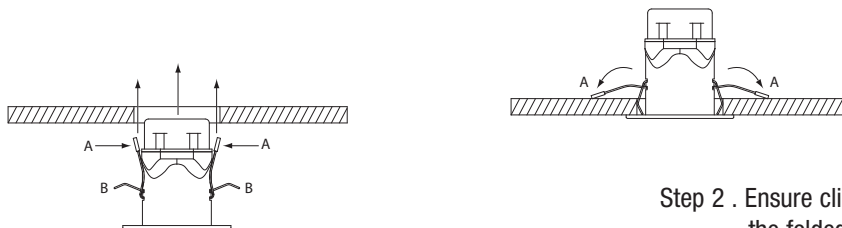

Step 1. Insert sensor with clips 'A' in the upright position

Step 2 . Ensure clips 'A' are in the folded down position

Connect Latching Valve Cable

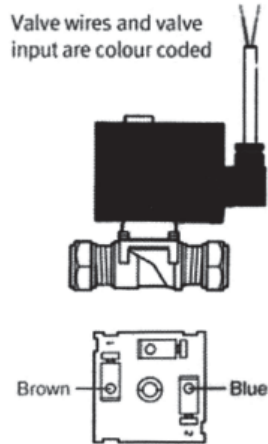

Run the latching valve cable to the sensor in conduit or within the building wall and ceiling.

Do not extend the cable as this will affect correct operation.

Locate plug on cable from the latching valve and detach it from circuit board.

The plug should be lifted directly upwards.

Fasten the latching valve cable to the plug on the circuit board by first removing the plug from the board. Lift plug directly upwards and hold plug so fixing screws are facing you.

Secure the brown cable into the right hand screw terminal and tighten.

Secure the blue cable into the left hand screw terminal and tighten.

Push the plug into the socket on the circuit board, positioned so screws face towards the centre of the board.

Finally, insert the cable from the battery pack into the circuit board inlet socket.

Once the power is connected, the system operates in test mode.

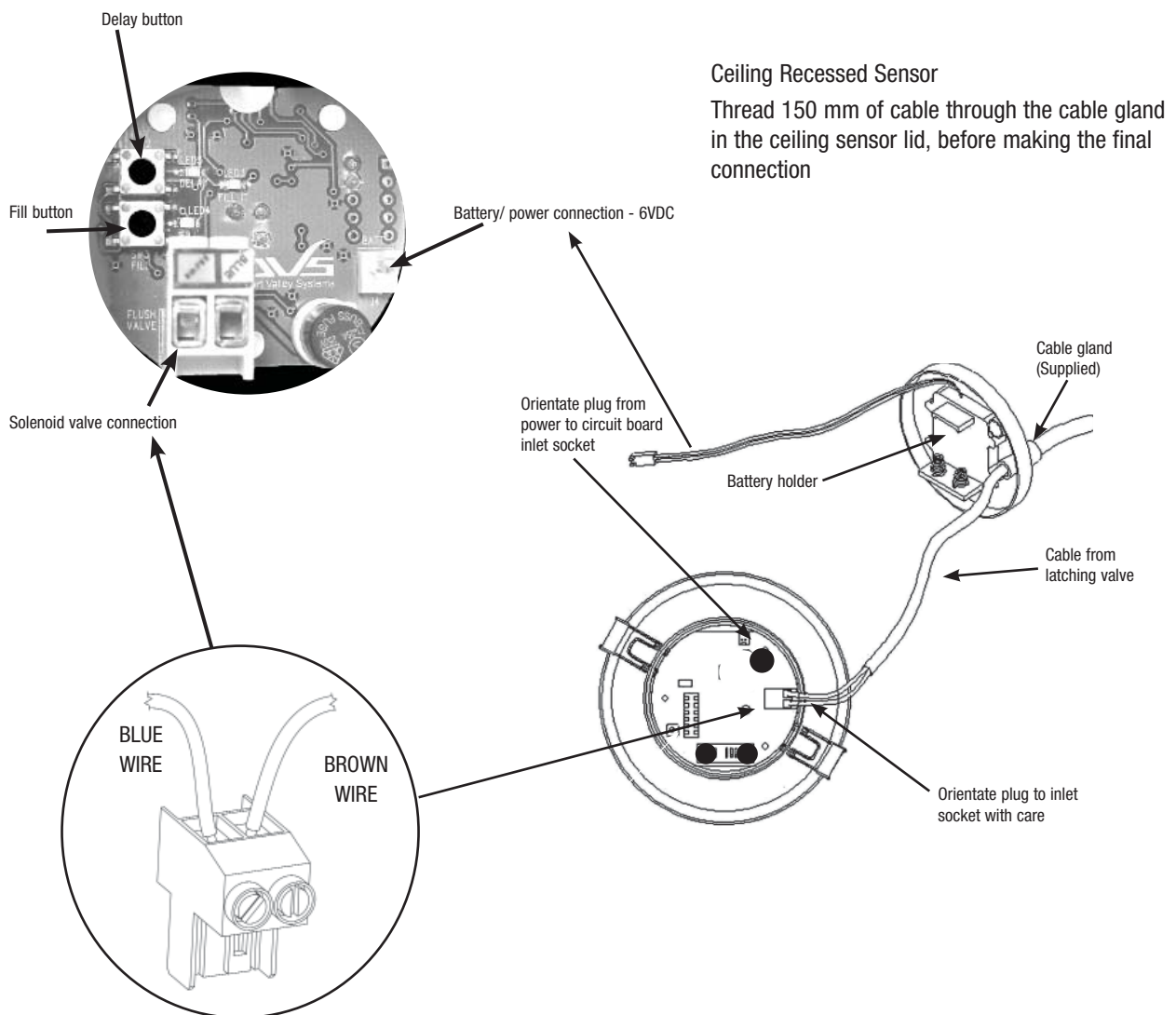

Connect Optional Power Pack

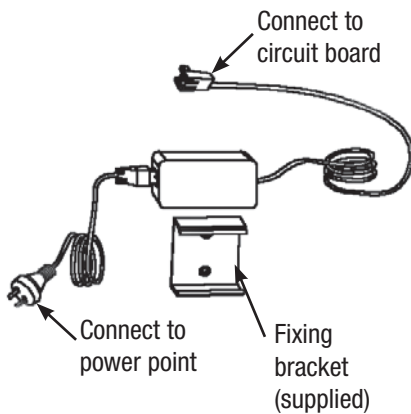

AC Power Pack product code 99031:

Locate battery holder and battery supplied with the system.

If connected, remove the battery cable plug from the circuit board.

Connect power pack to 220-240 volt 10 amp AC power point.

Carefully align the power pack outlet cable plug to circuit board inlet socket.

Firmly insert the cable plug from the power pack into the inlet socket. See diagram on page 7.

Set Flush Timing

FlushMaster WS003 ; WS004 ; WS006 ; WS007 and 99168 sensors:

On application of the power, the board closes the valve and defaults to the preset settings. It waits for approximately 2 minutes before starting to sense if anyone is present. On detection of a user, the LED on the front of the sensor will flash.

Preset Values

The FlushMaster Pearl board is shipped with the following Preset Values:

Janitorial Flush: Set at 12 Hours

Delay Time: Set at 45 seconds

Fill Time: Set at approx 5 seconds.

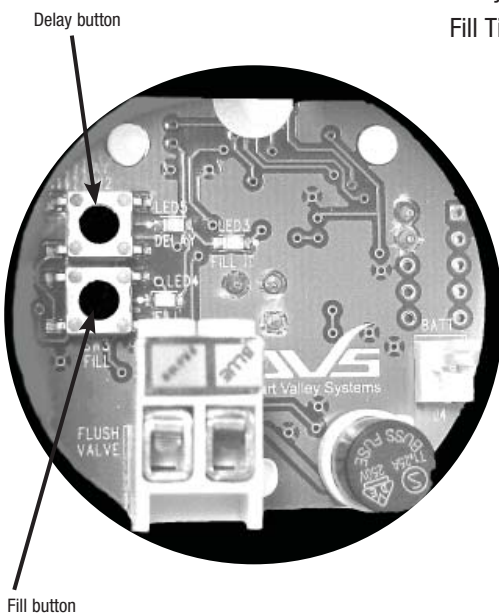

Set Flush Timing continued

Fill -LED pulses when fill button is held down

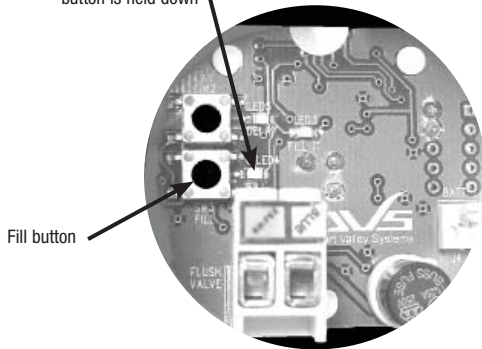

NOTE: Orient the PCB so the switches are positioned on the left hand side as you look at it. This is critical for correct setup.

Setting Fill Time

The board will continue to run the preset defaults until the values have been setup. The values can be set individually at any time except whilst the unit is filling the cistern.

To set the Fill Time, the installer pushes the lower left hand button once to activate the "Fill" light. Once the light is visible, push the button again and it will flash, each flash represents approximately one second of "fill time". When the required amount of water has been dispensed, push the lower left hand button again to shut the valve. Fill time is now set.

If the installer does not press the Fill Switch again, the counting will stop after 15 minutes and the Fill Time set to 15 Minutes.

Delay - LED Green

Delay - LED Red

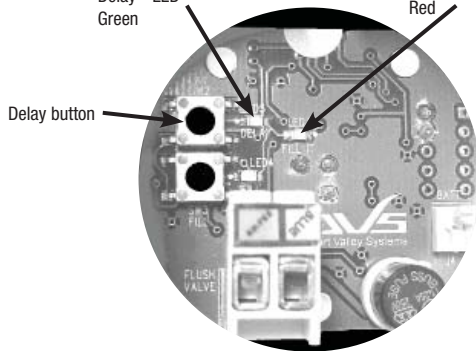

Setting Delay Time

To set Delay Time, push and hold the upper Delay button for approximately 2 seconds until the green Delay LED comes on (as shown).

Push the button again and the light will change from Green to Red as shown, repeat this as many times as required for Delay Time. Each push of the button adds 45 seconds Delay, up to a maximum of 30 minutes and changes the LED's from Green to Red to Green.

Valve Override

Once the unit has been set up, it is possible to open the valve using a straightened paper clip. Simply push the paper clip through the smallest hole on the face of the unit, and the micro switch will be triggered. This will automatically open the valve for the preset time.

LED's Change from Green to Red to Green

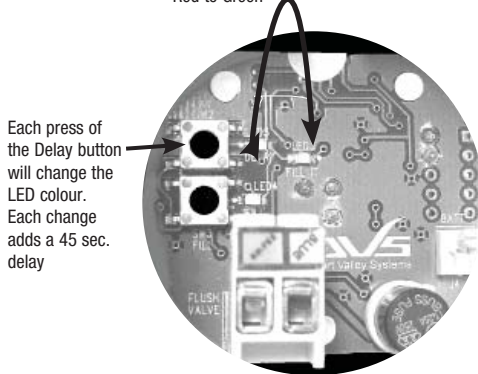

For example, after holding down Delay Switch for 2 seconds these combinations will equal the given time:

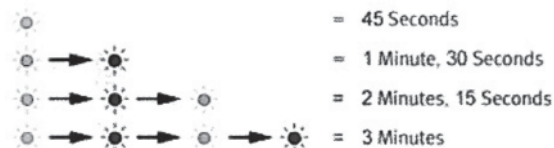

Can be continued upto a MAXIMUM OF 30 MINUTES

Completing Installation

On completion, fit the sensor lid to the mounting box by pushing it on tight. Fit sensor to the ceiling and wipe clean the outer surfaces. In the case of a surface mount sensor, ensure the body is securely fixed to the ceiling surface, then fit the cover by tightening the 4 fixing screws.

NOTE:

The FlushMaster goes through a "re-charge" for approximately 1 minute after completing a cycle, during this time the sensor remains dormant and will only target a user once recharge is complete.

Maintenance Instructions

Cleaning

Keep the slot openings in the face of the sensor clear of dirt.

Never clean the case with strong or abrasive cleaners.

Wipe with a soft cloth, warm water and dish washing liquid.

Never hose or spray any part of the flushing system.

Where the Zip FlushMaster is powered by a long life lithium battery a life of up to three years can be anticipated depending on frequency of activation.

However to avoid the inconvenience associated with any malfunction of the flushing system, it is recommended that both the battery and the latching valve diaphragm be replaced annually.

Where the optional power pack is fitted, the power must be turned off at the power point before any form of maintenance is attempted.

Battery Replacement

Remove protective cover from sensor housing, locate battery holder.

Remove cover from battery holder and remove existing battery.

Replace existing battery with lithium cell type CRP2 / 223A only (Zip product code 90098). Reset the Fill and Delay times (see notes on page 8 and 9).

Replace cover on battery holder and replace cover on sensor housing.

Battery low

When the battery voltage becomes low, the detection LED on front of unit will flash both Green and Red (as shown). This will continue until there is not enough power to open and close the valve. At this point the valve will close and the detection LED will only flash Red (as shown). At this stage the battery must be changed.

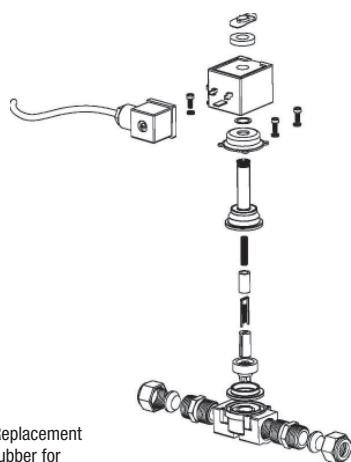
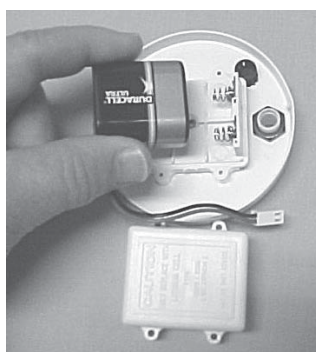

Replacement rubber for diaphragm

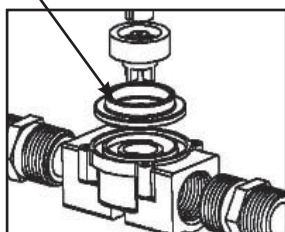

Valve Diaphragm Replacement

Isolate the water supply.

Remove fixing clip on top of latching valve coil by levering up clip with screw driver and clicking back until clip releases from shaft.

Lift coil, spring clip and spacer from latching valve shaft.

Carefully undo the 4 screws retaining the valve housing. When the last screw is about to be released, grip the valve body and top section as it is spring loaded.

Carefully separate the top section containing the spring and plungers from the lower body. The diaphragm should now be visible. Lift it out of position.

Remove the centre plastic piece from the rubber diaphragm. Fit the new diaphragm to the plastic centre. Replace it in the same orientation.

Re-assemble in the reverse of above. Note the position of all parts in the diaphragm kit for correct assembly. To order quote Zip part number 90279 Diaphragm Kit.

Problem Solving

Symptoms	Possible Causes	Suggested Action
Cistern Does not fill or direct inject does not flush.	Water supply turned off. Latching valve flow regulator full on. Latching valve installed backwards. Latching valve cable damaged or latching cable unplugged. Latching valve faulty. Sensor not activating.	Check water supply, turn on tap. Back off regulator screw. Reinstall latching valve correctly. Check cable and replug into sensor circuit board. Replace latching valve. Check sensor as below.
Cistern under fills, or direct inject flushes too long.	Sensor duration time set incorrectly. Latching valve flow regulator on.	Reset sensor timer switches.
Cistern over fills, or direct inject flushes for only 5 seconds at a time.	Sensor duration time set incorrectly. Latching valve flow regulator off.	Reset sensor timer switches.
Cistern fills or direct inject flushes for only 5 seconds at a time.	Sensor timers set to test mode.	Reset sensor timer switches.
Cistern fills or direct inject flushes for only 35 seconds at a time.	Sensor timers set to test mode and latching valve cable wires crossed.	Reset sensor timer switches and uncross latching valve wire connection.
Cistern fills or direct inject flushes continually except for time set as duration 'on' period.	Sensor cable wires crossed.	Uncross latching wire connection.
Cistern continues to fill during and after having just flushed.	Sensor duration time set incorrectly. Sensor timing out of sync with fill.	Reset sensor timer switches. Empty cistern, then restart timing.
Flushing will not stop.	False activation. Sensor not activating.	Check for sensor vibration. Check sensor as below.
Sensor not activating.	Battery flat. Power turned off. Sensor fuse blown. Lens slot blocked. Not detecting users. Faulty sensor.	Replace battery. Check Powerpack, turn on power. Replace fuse on circuit board. Clean lens slots. Reposition sensor appropriately. Replace sensor.

Contact Details

Head Office

Zip Heaters (Aust) Pty. Ltd.
ABN 46 000 578 727
67 Allingham Street
Condell Park NSW 2200
Postal: Locked Bag 80
Bankstown 1885 Australia

Website: www.zipheaters.com
Facsimile: (02) 9796 3858
Telephone: (02) 9796 3100
Free Call: 1 800 638 633

As Zip policy is one of continuous product improvement, changes to specifications may be made without prior notice. Images in this booklet have been modified and may not be true representations of the finished goods.

